



- External air compressor type soldering smoke absorber. No power supply is needed for operation
- Three inner filters attached on different levels absorb soldering smoke
- Up to 2 soldering irons can be connected with one HAKKO 490

## Specifications

**Model No.** 490-1

**Noise level** 39dB

**Working pressure** 392-686kPa (4-7kgf/cm<sup>2</sup>)

**Air consumption** 40L/min. (490kPa)

**Suction flow** 23L/min. (490kPa)

**Dimensions** Φ120×200(H)mm

**Weight** 1.5kg

\* Weight (unit only)

\* Use compressed air - no power supply is necessary.

## Features

Absorption Pipe Set R

Compatible soldering irons

- ▣ Any with a handle diameter of 16mm or smaller
- ▣ FM-2021, FM-2025, FM-2027, FM-2028, 907, 908 and more

Compact and noise free, making it perfect for low-noise environments and desktop use.

- ▣ Use compressed air-no power supply necessary.

## Compatible Soldering Station



[HAKKO FM-202](#)  
(Discontinued)



[HAKKO FM-203](#)



[HAKKO FM-204](#)  
(Soldering iron purchased separately)



[HAKKO FM-206](#)  
(Soldering iron purchased separately)



[HAKKO FX-838](#)



[HAKKO FX-888](#)



[HAKKO FX-950](#)



[HAKKO FX-951](#)



[HAKKO FX-952](#)



[HAKKO 936](#)  
(Not available for HAKKO 900S)



[HAKKO 937](#)  
(Not available for HAKKO 900S)



[HAKKO 938](#)

Absorption Pipe (No. B1953)  
 Metal Fitting For Absorption Pipe R (No. B3246)  
 Silicone Hose (No. B2184)  
 Hose Coupling Band (No. B1290)

Absorption Pipe Set R  
 (No. C1540)

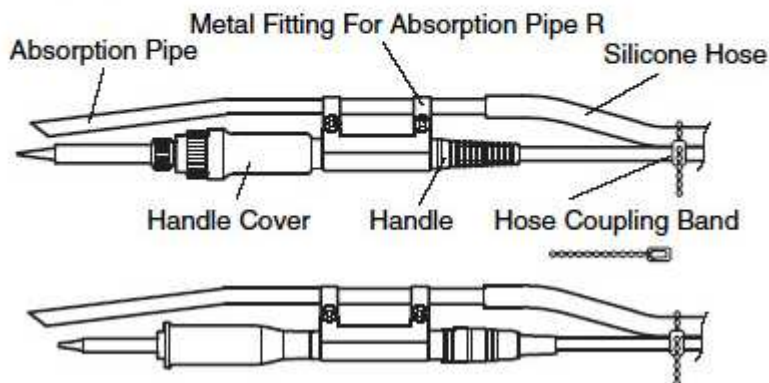









Compatible soldering irons:

Any with a handle diameter of 16 mm or smaller.

Product numbers examples :HAKKO FM-2021, FM-2025, FM-2027, FM-2028, FM-2030, FX-8801, FX-8301, 907, 908, 900M, 900L, 933, 934,

## Replacement Parts

	<b>Part No.</b>	<b>Name</b>	<b>Specifications</b>
	C1540	Absorption pipe set R	any w/ a handle dia. of 16 mm or smaller
	A1225	Top filter	
	A1226	Main filter	
	A1227	Pre-filter	set of 10
	B1953	Absorption pipe	6.3mm
	B2184	Silicone hose	1.5m
	B3246	Metal fitting for absorption pipe set R	
	B1290	Hose coupling band	set of 5

